



Spectra Precision HV302/HV302G



User Guide



TABLE OF CONTENTS

Introduction

For Your Safety

Components

How to Use the Laser System

Powering the Laser

Turning On/Off the Laser

Laser Setup

Standard Features

Rotation Mode

Scan Mode

Manual Mode

Y-/X-Single Slope Mode

Mask mode

Activating/Deactivating Standby Mode

Operating Examples

Determining the Height of Instrument (HI)

Using the optional HL760/HL760U receiver

Pairing the HL760/HL760U receiver with the transmitter

Special Features using the optional RC402N
RC402N Features and Functions
Powering the RC402N
Turning On/Off the RC402N Radio Remote Control
Pairing the remote control with the transmitter
MENU Features at the RC402N
Rotation
Scan
Automatic Grade Match
Automatic PlaneLok
Mask mode
Line Scan (Vertical Setup)
Beam Plunge (Vertical Setup)
Setting Menu
Info
Service menu
Setting Menu Selections
HI-alert selection
Sensitivity
Language
Radio Channel
CALIBRATION
Checking Calibration of the Y- and X-Axes
Checking Calibration of the Z-(vertical) Axis
Wall Mount
PROTECTING THE UNIT
CLEANING AND MAINTENANCE
PROTECTING THE ENVIRONMENT
WARRANTY
TECHNICAL DATA

Introduction

Thank you for choosing one of the Spectra Precision Lasers from the family of precision lasers. The HV302/HV302G laser is an easy-to-use tool that allows you to take accurate horizontal/vertical measurements, 90°- and plumb beam transfer.

For Your Safety

For hazardless and safe operation, read all the user guide instructions.



- Use of this product by people other than those trained on this product may result in exposure to hazardous laser light.
- Do not remove warning labels from the unit.
- The HV302/HV302G is a class 3A/3R laser (<5 mW; 600 - 680 nm / G - 520 nm) IEC 60825-1:2014)
- **Never** look into the laser beam or direct it to the eyes of other people.
- Always operate the unit in a way that prevents the beam from getting into people's eyes.
- If initial service is required, which results in the removal of the outer protective cover, removal must only be performed by factory-trained personnel.



Caution: Use of other than the described user and calibration tools or other procedures may result in exposure to hazardous laser light.

Caution: Using different than described at the HV302/HV302G user guide, may result in unsafe operation.

HV302/HV302G - Components

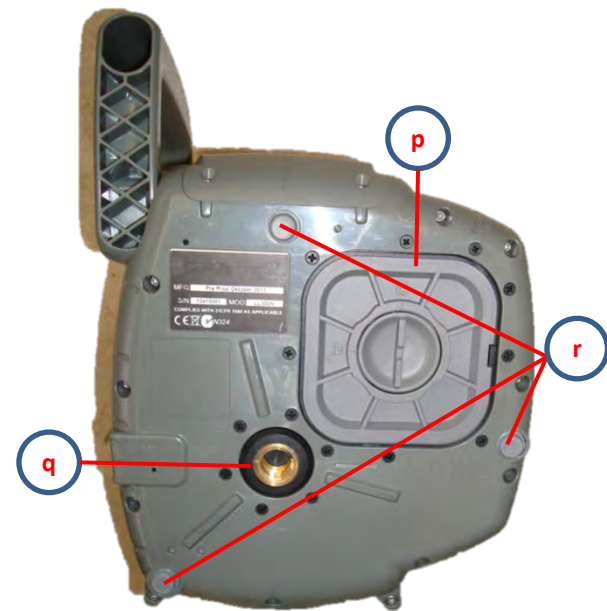
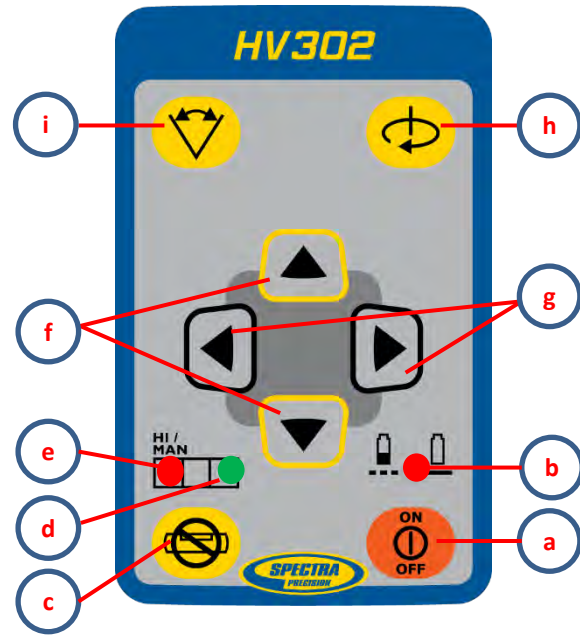

Components

- a Power Button
- b Battery LED
- c Manual/Standby Button
- d Leveling LED
- e HI/Manual/Standby LED
- f Up and Down Arrow Buttons
- g Left and Right Arrow Buttons
- h Rotation Button
- i Scan Button
- j Rotor
- k Sunshade
- l Sighting Guides
- m Axes-Alignment-Marks
- n Recharge Jack
- o Handle
- p Battery door
- q 5/8 x 11 Tripod Mounts
- r Rubber feet

How to Use the Laser System

Powering the Laser

Batteries

WARNING

Ni-MH batteries may contain small amounts of harmful substances.

Be sure to charge the battery before using it for the first time, and after not using it for an extended length of time.

Charge only with specified chargers according to device manufacturer's instructions.

Do not open the battery, dispose of in fire or short circuit; it may ignite, explode, leak or get hot causing personal injury.

Dispose in accordance with all applicable federal, state, and local regulations.

Keep the battery away from children. If swallowed, do not induce vomiting. Seek medical attention immediately.

Powering the HV302/HV302G

- 1 – HV302/HV302G is shipped with a rechargeable NiMH battery pack, it is keyed to prevent mis-insertion.
- 2 – The rechargeable battery pack can be charged inside of the unit
- 3 – Alkaline batteries can be used as a backup
- 4 – Plus and minus symbols at the battery door indicate how to put the alkalines into the battery compartment

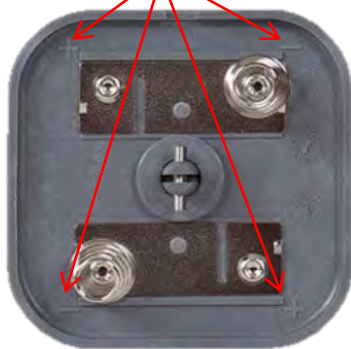

Installing Batteries

Remove the battery door by turning the center screw 90° counterclockwise. Insert batteries (or a rechargeable battery pack) into the housing so that the **negative poles are on the bigger battery spiral springs**.

DO NOT REMOVE RECHARGEABLE BATTERIES FROM THEIR HOLDER AND INSTALL ALKALINE BATTERIES, SEVERE DAMAGE TO UNIT WILL RESULT IF CHARGING IS ATTEMPTED.

Install the battery door and tighten it by turning the center screw 90° clockwise.

A mechanical switch prevents alkaline batteries from being charged. Only the original rechargeable battery pack allows charging within the unit. Any other rechargeable batteries have to be charged externally.

Recharging the Batteries

Note: The battery LED shows the approximate charge of the batteries.

The LED will flash when battery voltage is between 3.8 and 4.0 volts.

The LED will be on continuously when battery voltage is less than 3.8 volts.

The charger requires approx. 13 hours to charge empty rechargeable batteries.

For charging, connect the plug of the charger to the recharge jack of the unit.

New or long-time out-of-use rechargeable batteries reach their best performance after being charged and recharged five times. For Indoor applications the charger can be used as a power supply for the GL.

Alkaline batteries can be used as a backup. Insert 4 D-cell batteries noting the plus (+) and minus (-) diagrams at the battery door.

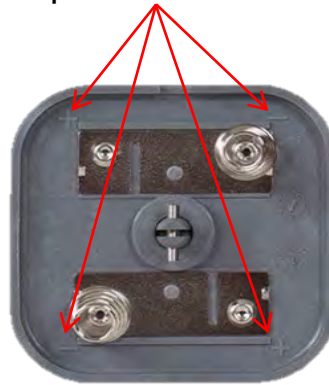

The batteries should only be charged when the laser is between 50° F and 104° F (10°C to 40°C). Charging at a higher temperature may damage the batteries. Charging at a lower temperature may increase the charge time and decrease the charge capacity, resulting in loss of performance and shortened life expectancy.

Laser Setup

Position the laser horizontally (tripod mount and rubber feet downward!) on a stable platform, wall mount or tripod at the desired elevation.

The laser recognizes automatically whether it is used horizontally or vertically when switched on.

Turning On/Off the laser

Press the power button to turn On the laser.

The LEDs (**b**, **d** and **e**) are turned on for 3 seconds. Self-leveling will start at once. The unit is leveled when the leveling LED (**d**) is no longer flashing (once every second). The rotor will not spin until the unit is leveled. For the first five minutes after the laser self levels, the LED (**d**) lights solid then flashes every four seconds to let you know the laser is still level and the HI alert has been activated.

To turn Off the laser, press and hold the power button again.

If the laser is positioned beyond its self-leveling range of $\pm 8\%$, the manual and leveling indicators flash simultaneously and a warning sound is emitted. Reposition the laser within its self-leveling range.

Once leveled, the unit constantly monitors its level condition. The height change (HI) alert is activated 5 minutes after self-leveling was performed. The green LED (**d**) flashes every 4 seconds and HI appears at the right corner of the optional remote control's display.

Level errors $> 30 \text{ mm}/10 \text{ m}$ put the unit into alert mode because they are generally caused by a disturbance that could lead to inaccurate measurements. When entering into alert mode, the rotation stops, the laser beam turns off, a warning sound is heard and the HI/MAN LED (**e**) flashes 2 x per second. Turn the unit off and then on again. To ensure your former elevation, now you have to check or arrange the exact height.

Standard Features

Rotation Mode

Rotation speed can be selected using the Rotation button as well as using the RC402N menu.

Repeatedly pressing the **Rotation** button toggles through 0, 10, 80, 200, 600 rpm regardless if the unit is in automatic or manual mode. At 0 rpm, the beam stops automatically close to the +Y- axis center position.

When set up horizontally in automatic mode, using buttons **Up/Down** increases/decreases the rotor speed from 10 to 80 and then continuously in 10 rpm increments up to 600 rpm.

Note: The zone-scan button can be used to stop the beam's rotation.

Pointing mode

At 0 rpm, buttons **Left/Right** move the beam to the left/right side. When set up vertically at 0 rpm, buttons **Up/Down** can be used for moving the beam clockwise/counterclockwise and to align the rotor vial.

Scan mode

Scan mode can be selected using the Scan button as well as using the RC402N menu.

Quickly press and release the **Scan** button to toggle between the pre-selected scan sizes 5°, 15°, 45°, 90°, 180° and 0; regardless if the unit is in automatic or manual mode.

When working in horizontal automatic mode, press and hold button **Up/Down** to increase/decrease the line size in 5° increments. Press and hold button **Left/Right** moves the scan line to the right/left direction.

When used in automatic vertical mode, pressing and holding button **Up/Down** moves the scan line counterclockwise/ clockwise. When set up vertical, pressing and holding button **Left/Right** moves the scan line into the right/left direction regardless if in automatic or manual mode. For the first 4 seconds, the scan line moves slowly than faster.

Note: The rotation control button can be used to stop the scan mode.

Standard Features

Manual mode

Pressing and releasing **Manual** button activates/deactivates the manual mode regardless if set up horizontal or vertical.

Manual mode is indicated by the flashing (once every second) red LED (**e**).

In Manual mode (horizontal), the Y-axis can be sloped by pressing the **Up** and **Down** Arrow-buttons on the laser or remote control. Additionally, the X-axis can be sloped by pressing the **Left** and **Right** Arrow-buttons on the laser or the remote control.

To resume automatic self-leveling mode, press the manual button **three** times.

Pressing the **Up** and **Down** arrow buttons on the laser or the remote control in vertical mode adjust the slope of the laser beam. The **Left** and **Right** arrow buttons on the laser or the remote control can be used to align the laser beam to the right/left side.

To resume automatic self-leveling mode, press the **Manual** button again.

Y- and X- Single Slope Mode

The **Manual** button on the laser and remote control toggles the unit through Manual, the Y- and X- axis Single Slope Mode, then Automatic Mode. To activate the Y-axis single slope mode, press the **Manual** button at the laser or remote control **twice** and for X-axis single slope mode **three** times. The Y-axis mode is indicated by the simultaneously flashing red **e** and green **d** LEDs (once every second); in X-axis mode the LEDs flash every three seconds.

In Y-axis single slope mode, the Y-axis can be sloped by pressing the **Up** and **Down** Arrow-buttons on the laser or remote control, while the X-axis remains in automatic self leveling mode (e.g. when setting up sloped ceilings or driveways). In X-axis single slope mode, the X-axis can be sloped by pressing the **Right** and **Left** Arrow-buttons on the laser or the remote control, while the Y-axis remains in automatic self leveling mode.

To resume automatic self-leveling mode from Y-axis single slope mode, press the **Manual** button **twice**; from X-axis single slope mode, press the **Manual** button **once**.

Mask Mode

Mask Mode – allows you to electronically turn off the rotating laser beam (electronic shutters) in up to 3 lighthouse windows to prevent interference with other receivers on the jobsite. Mask Mode can be selected as a standard feature as well as using the menu.

To activate the mask mode on the + or -Y-axis, press the **Up** or **Down** arrow button at the laser or remote control, then within <1 second press and release the **Manual** button.

Press the **right** or **left** arrow button at the laser or remote control in sequence with the **Manual** button to activate/deactivate the mask mode for the + or – X axis.

The RC402N display indicates which side of the laser the beam has been electronically turned off.

Note: The unit always powers up with the mask mode deactivated (default).

Activating/Deactivating Standby mode

Press and hold the **Manual** button at the laser or remote control for 3 seconds activates the Standby mode.

The self-leveling and rotation will be stopped and the beam will be turned off while the HI alert is still active.

The HI/MAN LED at the laser flashes red every 5 seconds while the RC402N display shows Standby.

To deactivate Standby mode and restore full operation of the laser, press and hold the



Manual button at the laser or remote control again for 3 seconds.

Applications

Interior

Acoustical Ceilings

1. Determine and mark the finished ceiling height and securely install the first piece of wall molding to this height.
2. Attach the laser onto the wall molding by sliding the wall mount over the wall molding and turn the locking screws until the wall mount is secured.
3. Make sure the locking knob on the wall mount is loose.
4. To adjust the elevation, turn the fine height adjustment screw until the slider edge is at the zero (0) mark on the scale (wall molding elevation), and turn the locking knob to tighten it.

Note: To minimize accidental dropping, insert a ceiling wire through the laser's handle and twist the wire.



Drywall and Partitions

1. Slide the laser along the elevation scale to the short line at the scale above the 0-mark.
2. Place the laser over the near wall-control point.

Note: If the wall mount is attached to the floor track, make sure the laser is set to the edge of the track (0-mark).

3. Use the **Left/Right** arrow button to point the beam towards the far wall-control point.
4. Go to the far wall-control point and use the remote control to adjust the line of the laser until the laser beam is aligned to the mark.

Note: If you're using the perpendicular beam for alignment, use the RC402N menu to activate the **Beam Plunge** function to move the perpendicular beam to your far wall-control mark.

Note: When the laser beam is on the mark, press the **Manual** button, then use the line buttons for left and right adjustment.

Note: After line adjustment is completed, press the **Manual** button so the laser will automatically re-level.

5. Install the track or mark the track line on both the floor and ceiling for future track installation.

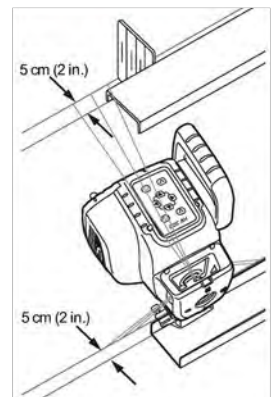

Determining the Height of Instrument (HI)

The height of instrument (HI) is the elevation of the laser's beam.

The HI is determined by adding the grade-rod reading to a benchmark or known elevation.

Set up the laser and place the grade rod on a job-site benchmark (BM) or known elevation.

Slide the receiver up/down the grade rod until it shows an on-grade reading.

Add the grade-rod reading to the benchmark to determine the height of instrument.

Example:

Benchmark = 30.55 m (100.23 ft)

Rod reading = +1.32 m (+4.34 ft)

Height of instrument = 31.87 m (104.57 ft)

Use this HI as a reference for all other elevations.

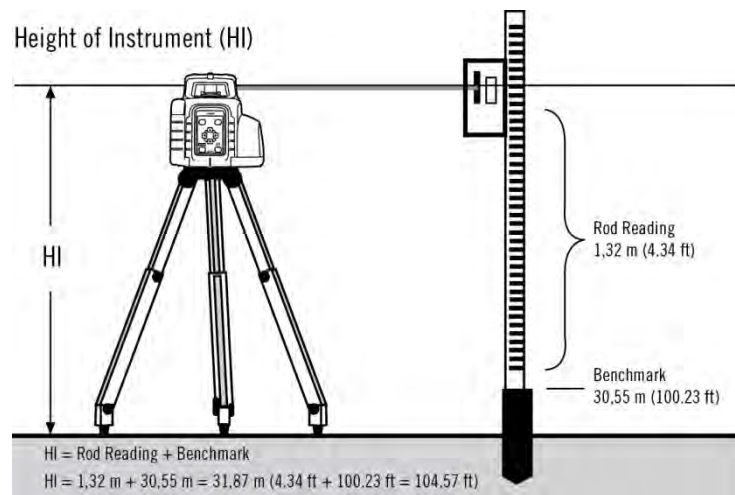

Vertical Application

Set up the laser on the tripod by using the vertical mounting thread and allow the laser to level in automatic self-leveling mode.

Push the Manual mode button and rotate the laser until the vertical laser plane aligns with the receiver's on-grade position.

Push the manual button again to resume automatic self-leveling mode and use the **Left** and **Right** arrow buttons for fine adjustments.

Using the Y-Axis Single Slope Mode

1. Set up the laser and align it to the desired slope hub using the sighting guides on the sunshade.
2. Check the laser beam elevation close to the laser.
3. To activate the Y-axis single slope mode, press the manual mode button twice. The red and green LED flashes simultaneously (once a second).
4. Set the grade rod with the receiver attached to it on the desired slope/elevation hub.
NOTE: DO NOT change the receiver position at the rod
5. Press the up and down arrow buttons until you get an on-grade reading on the receiver.
6. Check the elevations along the direction of the slope

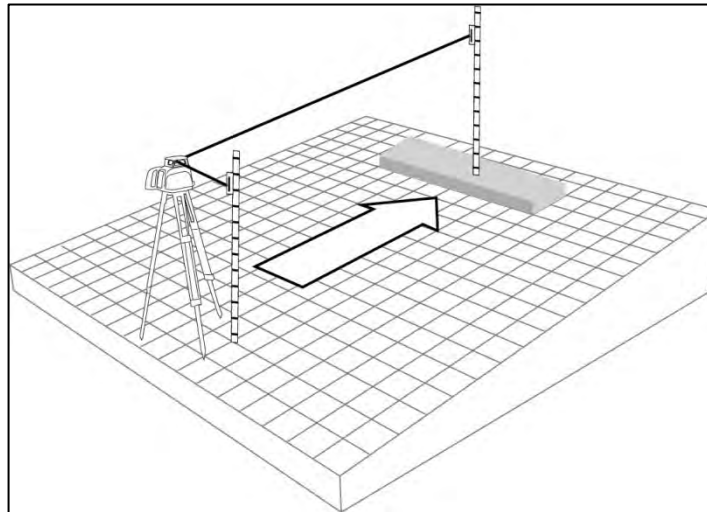

Using the optional HL760/HL760U receiver

To pair the HL760/HL760U receiver with the transmitter

Make sure the transmitter is turned off.

First, turn on the receiver, then press and hold the Deadband (A) and Audio (B) buttons for two seconds.

After two seconds, the display shows MENU first, then RDIO

Press and release the Units (C) button – display shows the current radio mode.

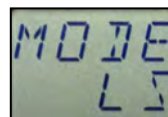

or



or

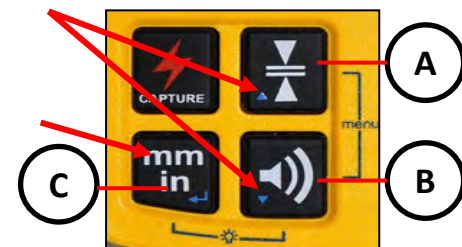

If not already set to **LS**, press Units (C) button (current mode flashes) and then press Deadband (A) or Audio button (B) until **LS** is displayed.

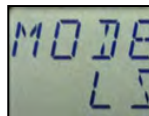

Press Units (C) button again to enter selection.

Press and release the Audio (B) button – display shows **PAIR**.



Press the Units (C) button again – the display shows **PAIR** and a rotating bar.

Then press and hold the **Manual** button and turn on the transmitter (Battery LED flashes fast).



After completing PAIR, **OK** will be displayed.

The laser pairs now automatically with the new receiver and turns back to the standard function.

Press and release the HL760/HL760U Power button two times to exit the menu at the receiver.

A laser symbol and an antenna is lit to confirm the receiver is ready for communication with the laser.

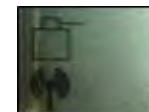

Special Features using the optional RC402N

RC402N Features and Functions

The remote control mirrors the basic functionality of the laser keypad and offers additional features using the **M** and **E** buttons.

M-Button : Quickly press and release **starts the MENU entry** and can be used to return to the previous menu position

E-Button: Quickly press and release starts the selected mode

Manual Button: Quickly press and release activates/deactivates the manual mode/ single slope modes

Up/Down Arrow Buttons

Left/Right Arrow Buttons

ON/OFF button - press for 1 second to turn on the unit; press and hold for 2 seconds to turn off the unit

RC402N Battery- Status- LED (red)

Battery status laser
Mask mode indication



Powering the RC402N

1. Open the battery door using a coin or similar pry device to release the battery door tab on the RC402N. RC402N will be shipped with alkaline batteries. Rechargeable batteries can be used optional but need to be charged externally.
2. Insert two AA batteries noting the plus (+) and minus (-) diagrams inside the battery housing.
3. Close the battery door. Push down until it “clicks” into the locked position.



Turning On/Off the Radio Remote Control

The radio remote control is a hand-held device that allows you to send operational commands to the laser from a remote location.

Press the power button to turn on the radio remote control.

Note: When the remote control is initially turned on, the standard display (model number and software version) appear for the first 3 seconds, then the RC402N LCD shows the actual laser function.



horizontal setup



vertical setup



Manual mode



Y-axis
slope mode



X-axis
slope mode

With every button press, the LCD backlight is activated and turns off automatically if no button is pressed for 8 seconds.

To turn off the radio remote control, press and hold the power button for 2 seconds. If the RC402N is outside of the operating range or not paired with the transmitter, the LCD shows the model number and software version.



Note: 5 minutes after the last button press, the remote control turns off automatically.

Pairing the remote control with the transmitter

First, make sure the transmitter and the remote control are turned off. Then press and hold the **Manual** button and turn on the transmitter. During the next 6 seconds repeat the same steps on the remote control.

The Laser beeps and the remote's display shows Pairing OK for one second and then the same function as the laser is actually working to indicate the transmitter has been matched with the remote control.



RC402N Menu Functions

Press and release **M** button at the Standard Display to enter the MENU.

The actual available function will be marked in arrow brackets >> <<.

A down arrow at the the right site indicates that the user can scroll down through the menu using the **down** arrow button.

After going to the next menu row, an up/down arrow at the the right site indicates that the user can scroll up/down through the menu using the **Up/Down** arrows buttons.

Pressing and releasing button **M** changes the unit always back to the standard or previous display.

Press and release the **Up/Down** buttons until the desired function at the selected menu row is marked.

Press and release button **E** to open the submenu OR start the selected function.

Menu functions for the HV302/HV302G

Horizontal Setup

»Rotation« Scan ↓	»Grade Match« ↑ PlaneLok ↓	Mask Mode ↑ »Settings« ↓	Info ↑ »Service«
----------------------	-------------------------------	-----------------------------	---------------------

Vertical Setup

»Rotation« Scan ↓	PlaneLok ↑ »Line Scan« ↓	Beam Plunge ↑ »Mask Mode« ↓	Settings ↑ »Info« ↓	Info ↑ »Service«
----------------------	-----------------------------	--------------------------------	------------------------	---------------------

Rotation

Press and release the **M** button at the Standard Display and select **>>Rotation<<**.

Press and release button **E** to display the actual rotation speed. Use the **Up/Down** buttons to select toggle through the pre-selected rotation speeds 0, 10, 80, 200 and 600 rpm. Confirm the desired speed by pressing the **E** button.

At 0 rpm, the beam stops automatically close to the +Y- axis center position.

When set up horizontally in automatic mode, using buttons **Up/Down** increases/decreases the rotor speed from 10 to 80 and then continuously in 10 rpm increments up to 600 rpm.

Note: The zone-scan button at the laser can be used to stop the beam's rotation.

Scan Mode

Press and release the **M** button at the Standard Display and select **>>Scan<<**.

Press and release button **E** to display the actual scan size. Use the **Up/Down** buttons to toggle through the pre-selected scan sizes 5°, 15°, 45°, 90°, 180° and 0. Confirm the desired scan size by pressing the **E** button.

When working in horizontal automatic mode, press and hold button **Up/Down** to increase/decrease the line Size in 5° increments. Press and hold button **Left/Right** moves the scan line to the right/left direction.

When used in automatic vertical mode, pressing and holding button **Up/Down** moves the scan line counterclockwise/ clockwise. When set up vertical, pressing and holding button **Left/Right** moves the scan line into the right/left direction regardless if in automatic or manual mode. For the first 4 seconds, the scan line moves slowly than faster.

Note: The rotation control button at the laser can be used to stop the scan mode.

Automatic Grade Match

The Grade Match mode can be activated in horizontal automatic mode.

In Grade Match mode, the laser can be used to connect two known elevation points (up to 100 m (330 ft) located on the Y-axis of the laser.

1. Set up the laser over the reference point.
2. Attach the HL760/HL760U receiver to a grade rod. Check the laser's elevation next to the laser then position the receiver at the second point **WITHOUT** changing the receiver's elevation on the rod.
3. Use the sighting guides on the top of the laser to align the laser to the receiver. Turn the laser on the tripod until it is roughly aligned to the receiver's position
4. Press and release the **M** button at the Standard Display and select **>>Grade Match<<**.
5. Press and release the **E** button to open the Grade Match submenu; select the Y-axis then press the **E** button to start Grade Match.

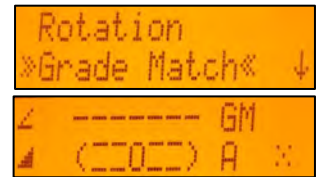
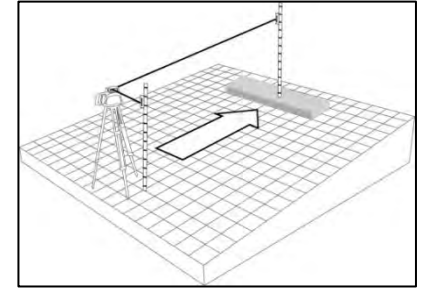

Note: The laser starts to search for the receiver while the RC402N display shows flashing GM. The HL760/HL760U display shows also a flashing **-GM-** during the time the laser is searching and adjusting the beam to the on-grade position.

When Grade Match has been completed, the HL760/HL760U goes back to the standard elevation display while the laser stays in the Y-axis single slope mode.

The red and green LED flash simultaneously (once a second).



When the slope work has been finished, press the **Manual** button **two times** to go back to automatic mode.

Exiting of Grade Match can be done by pressing the **Manual** button where the unit goes always back to automatic mode.



Automatic PlaneLok

The PlaneLok mode can be activated in horizontal automatic and vertical automatic and manual mode. In PlaneLok mode when set up horizontal, the beam will be locked to a fixed elevation point (up to 100 m (330 ft) located on the Y-axis of the laser. For keeping vertical alignments fixed to the direction position, PlaneLok can be used on the X-axis.

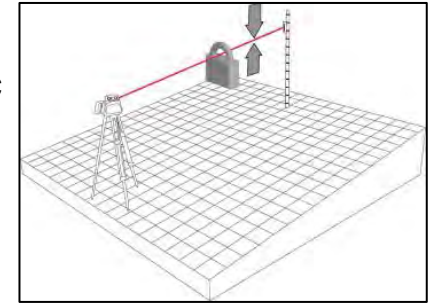

1. Set up the laser over the reference point.
2. Attach the HL760/HL760U receiver to a grade rod. Check the laser's elevation next to the laser then position the receiver at the second point WITHOUT changing the receiver's elevation on the rod.

```
Grade Match ↑
*PlaneLok* ↓
```

3. Press and release the **M** button at the Standard Display and select **>>PlaneLok<<**.
4. Press and release the **E** button to open the PlaneLok submenu; select the **Y**-axis when set up horizontally or the **X**-axis when set up vertically; then press the **E** button to start PlaneLok.

```
*PL Y*
```

Note: The laser starts to search for the receiver while the RC402N display shows flashing PL. The HL760/HL760U display shows a flashing **-PL-** during the time the laser is searching and adjusting the beam to the on-grade position.

```
PL
( ) A X
```

When PlaneLok is complete, **-PL-** stops flashing at the HL760/HL760U and RC402N display.

When setting up the transmitter vertical, PlaneLok can be used at the X-axis.

1. Press and release the **M** button at the Standard Display and select **>>PlaneLok<<**.
2. Press and release button **E** to open the PlaneLok submenu; select the **X**-axis; then press button **E** to start PlaneLok.

```
*PL X*
```

Note: When used in **vertical mode**, the receiver has to be placed with the **photocell on the bottom side**. For getting the best performance and a longer operating range set up the HL760/HL760U at least 0.5 m (2 ft) above the ground.

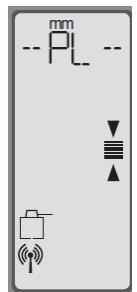
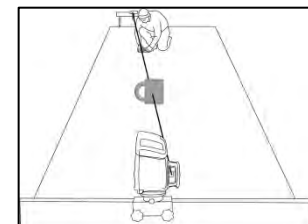

Note: In every PlaneLok mode the laser continues to servo to the receiver's signals. Any loss of signal over an extended period of time (1 minute) causes the laser to go into the HI-alert condition (beam turns off, rotor stops and a warning message occurs at the RC402N LCD). PlaneLok mode can be reactivated after the HI-alert condition has been deleted with the **E** button.

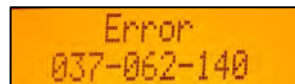

Exiting of PlaneLok can be done by pressing the **Manual** button or any HL760/HL760U button where the unit goes always back to automatic mode.

Line Scan (Vertical Setup)

When setting up the unit vertical, Line Scan centers the rotor horizontally and can be used to align the laser reference to a desired line position.

Press and release the **M** button at the Standard Display and select **>>Line Scan<<**.

Press and release button **E** to start Line Scan.

The rotor checks the limits of the X- axis (**LS** is flashing) and stops at the center position.

Pressing the **Manual** button stops the movement and changes the unit into manual mode.

Corrections left and right can be done using **Left/Right** arrow buttons.

Press and release the **Manual** button to change the unit back to full automatic mode.



Beam Plunge (Vertical Setup)

Beam Plunge centers the rotor vertically and can be used to align the plumb beam to a desired vertical position, e.g., when doing Interior layout.

Press and release the **M** button at the Standard Display and select **>>Beam Plunge<<**.

Pressing and releasing button **E** activates the Beam Plunge mode while the rotor checks the limits of the Y- axis and switches back to automatic mode at the center position.

Pressing the **Manual** button stops the movement and changes the unit into manual mode.

Corrections up and down can be done using button **Up/Down**; for left/right corrections use button **Left/Right**.

Press and release the **Manual** button to change the unit back to full automatic mode.

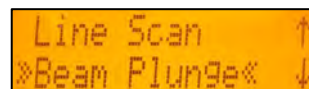

Mask mode

Press and release the **M** button at the Standard Display and select **>>Mask Mode<<**.

Depending on which side the beam should be turned off, the required side can be selected. Press and release the **E** button, the mask symbol occurs.

For selecting the side, press and release one of the arrow button.

When all areas have been set, press button **E** to store the mask sector selection until the unit will be turned off.

Note: The unit always powers up with the mask mode deactivated (default).



```
PlaneLok ↑
»Mask Mode« ↓
```



```
X
```



```
L1 ↑
R1 ↓
```



```
L1 ↑
R1 ↓
```

Setting Menu

Please see the Setting Menu details at the following pages.

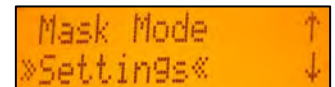

```
Mask Mode ↑
»Settings« ↓
```

Info

Press and release the **M** button at the Standard Display and select **>>Info<<**.

Up and **Down** Buttons can be used to toggle between **About LS**, **Runtime** and **Radio**

Press and release button **E** to confirm the selection.

The laser information (software version, serial number.), the runtime and the radio channel of the laser will be displayed.



```
Settings ↑
»Info« ↓
```

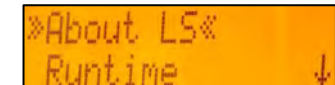

```
»About LS« ↑
Runtime ↓
```



```
Runtime ↑
»Radio« ↓
```



```
»SN« ↑
Rev. ↓
```



```
SN ↑
»Rev.« ↓
```



```
About LS ↑
»Runtime« ↓
```



```
Runtime ↑
»Radio« ↓
```



```
40E46DCECD14D74F
```

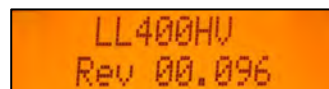

```
LL400HV
Rev 00.096
```



```
000003h 58m
```

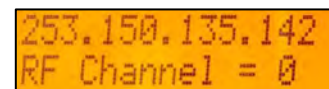

```
253.150.135.142
RF Channel = 0
```

Service

Press and release the **M** button at the Standard Display and select **>>Service<<**.



Buttons **Up/Down** can be used to toggle between **Calibration X** and **Calibration Y** OR **Calibration Z** when set up vertically.



Press and release button **E** to confirm the selection.

The calibration at the selected axis starts the field calibration procedure.

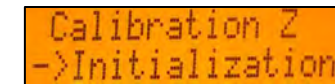
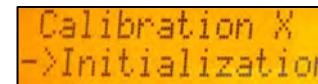
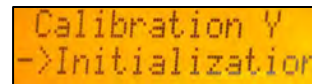

Setting Menu

Press and release the **M** button at the Standard Display and select **>>Settings<<**.



Press and release button **E** to open the Setting Menu; select the desired function then press button **E** to open the selected submenu function OR start the selected function.

HI-alert Selection

Select **HI Alert** and press and release button **E** to open the HI Alert menu.



The desired HI-alert: **5 min.**(Default), **30 seconds** and **HI-off**) can be selected using the **Up/Down** buttons.

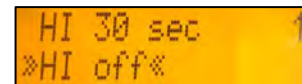

Press and release button **E** to confirm the selected HI-alert.

Sensitivity Selection

Select >>**Sensitivity**<< and press and release button **E** to open the Sensitivity menu.



The desired Sensitivity: Low, Mid (Default) and High) can be selected using the **Up/Down** buttons.



Press and release button **E** to confirm the selected Sensitivity.

Select Language

Select >>**Language**<< and press and release button **E** to open the Language menu.

Use **Up/Down** buttons to select the required local language (EN, DE, IT, FR, ES, PT, NL, DA, NO, SV, FI, PL, TR, CZ).

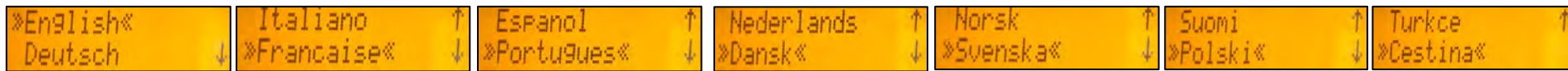

Press and release button **E** to store the selected Language; unit falls back to the standard menu.

Radio Channel

Select >>**Radio Channel**<< at the laser and press and release button **E** to open the Radio Channel menu.

The desired Radio Channel: 0 to 5 can be selected using the **Up/Down** buttons.



Press and release button **E** to confirm the selected Radio Channel.

After changing the Radio channel, **the RC and HL needs to be paired again.**

Troubleshooting

Any error message can be deleted with a short press of button **E**. The table shows the related description and possible solutions.

The next service center should be contacted if a different error message as shown at the table will be displayed.

Error codes	Description	Solution
21	Temporary EEprom problem	Press the E button to delete the error message
120	HI alert - Unit Height changed	Check laser beam elevation
130	Mechanical Limit during Grade Match / PlaneLok	Check if existing slope is above +/-9%
140	Laser beam blocked	Make sure there are no obstacles between the transmitter and the HL760/HL760U
141	Time Out - Alignment could not be completed in the allowed time	Check radio operating range/ connection; check stable laser setup
150	No receiver – HL760/HL760U Receiver not available for single axis automatic function	Make sure the HL760/HL760U is on and paired
152	No receiver - The laser searched for the receiver but could not find it	Check the operating range for auto function and restart the auto alignment
153	Lost Receiver - The laser searched and found the receiver but then lost it	Check the operating range for auto function and restart the auto alignment
155	More than two paired receivers are available during automatic alignment function.	Make sure only two HL760/HL760U receivers are turned on.
160	X or Y level sensor defect	Contact service center

CALIBRATION

Checking Calibration of the Y- and X-Axes

1. Set up the laser 30 m (100 ft) from a wall and allow it to level.
2. Allow the unit to warm up for 20 minutes.
3. Raise/lower the receiver until you get an on-grade reading for the +Y axis. Using the on-grade marking notch as a reference, make a mark on the wall.

Note: For increased precision, use the fine-sensitivity setting (1.5 mm/ 1/16 in.) on the receiver.

4. Rotate the laser 180° (-Y axis toward the wall) and allow the laser to re-level.
5. Raise/lower the receiver until you get an on-grade reading for the -Y/axis. Using the on-grade marking notch as a reference, make a mark on the wall.
6. Measure the difference between the two marks. If they differ more than 3 mm at 30 m (1/8 inch at 100 feet), the laser needs calibrating.
7. After checking the Y-axis, rotate the laser 90°. Repeat the above starting with the + X axis facing the wall.

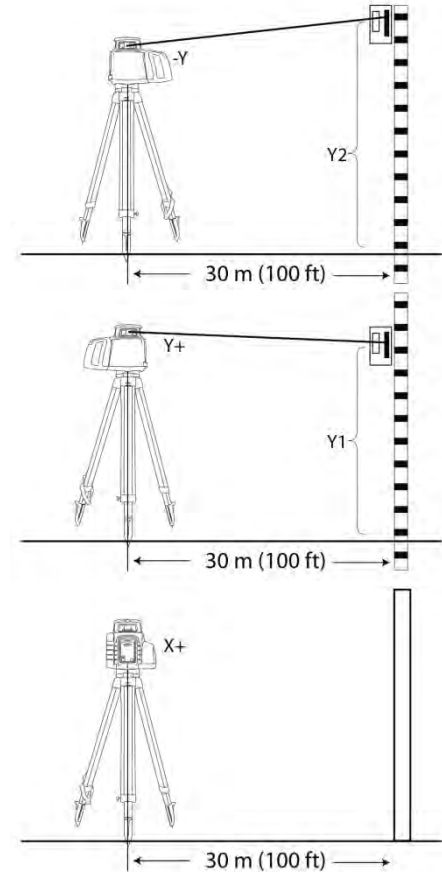

Checking Calibration of the Z-(vertical) Axis

To check vertical calibration, you need a plumb bob with at least 10m (30ft) of string.

1. Suspend the plumb bob in front of a house i.e., attached to a window frame whose window height is at least 10m (30ft).
2. Set up the laser in vertical so that the laser beam strikes the receiver's on-grade position at the top of the string.
3. Look for any deviation using the receiver from the top of the string to the bottom of it. If the deviation is more than 1mm (<1/16 in.), the vertical axis needs calibrating.

Wall Mount

1. Nail Holes (3) – allows you to hang the wall mount onto nails or screws.
2. Locking Screws – lock/unlock the wall mount at the wall molding or floor track.
3. Locking Knob—tightens/loosens the sliding bracket in place after it has been positioned along the elevation scale.
4. 5/8" –11 Laser Mount – lets you connect the laser to the wall mount.
5. Fine height adjustment screw—lets you fine adjust the laser's position on the wall mount.
6. Adjustment screw – adjust the slider's movement tightness considering the laser weight.
7. Elevation Scale – provides graduated marks that indicate the position of the laser relative to the wall molding height. The adjustment range on the scale is from 3.1 cm (1 1/4 in.) above wall-molding height to 5 cm (2 in.) below it. (The “-2” position is aligned with the horizontal centerline at the ceiling target.)
8. Reading Edge – allows you to adjust the laser position appropriate for your application needs.
9. Vertical-Alignment Notch—shows the position of the laser beam when the laser is set up in vertical mode and is moved up to the top (3.1 cm [1 1/4 in.]) stop.

Note: The laser handle should be used as a safety hole —provide a place to tie a safety wire when mounted to a wall.

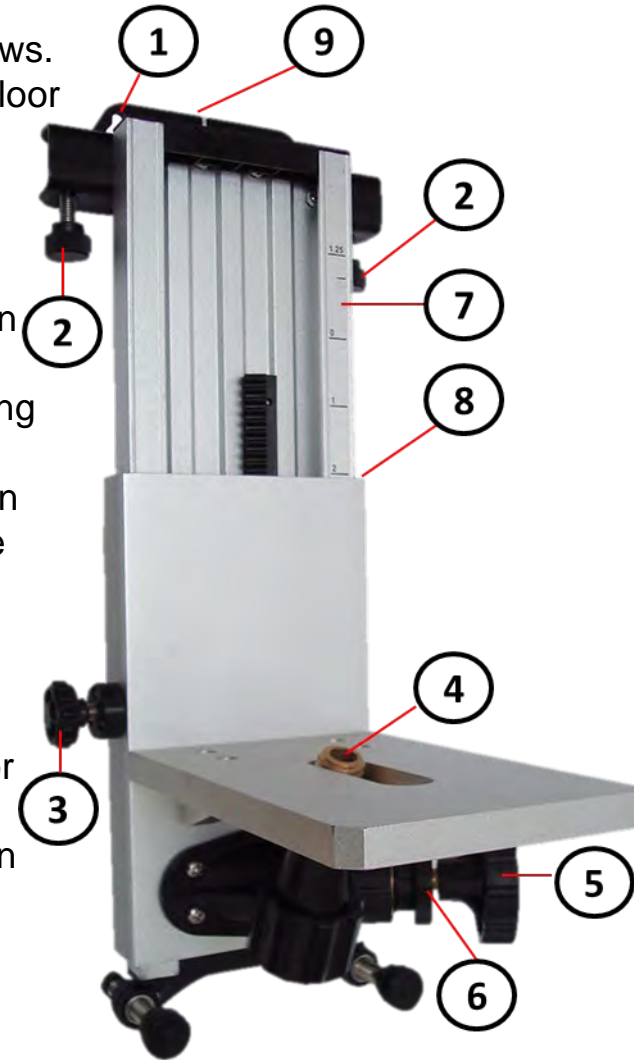

PROTECTING THE UNIT

Do not expose the unit to extreme temperatures or temperature changes (do not leave inside the car). The unit is very robust and can resist damage if dropped even from tripod height. Before continuing your work, always check the leveling accuracy. See **Checking Calibration** section. The laser is water proof and can be used indoors and outdoors.

CLEANING AND MAINTENANCE

Dirt and water on the glass parts of laser or prism will influence beam quality and operating range considerably.

Clean with cotton swabs.

Remove dirt on the housing with a lint-free, warm, wet and smooth cloth. Do not use harsh cleansers or solvents.

Allow the unit to air dry after cleaning it.

PROTECTING THE ENVIRONMENT

The unit, accessories and packaging ought to be recycled.

This manual is made of non-chlorine recycling paper.

All plastic parts are marked for recycling according to material type.



Do not throw used batteries into the garbage, water or fire. Remove them in compliance with environmental requirements.

Warranty

Spectra Precision LLC warrants the HV302 to be free of defects in material and workmanship for a period of five years (HV302G three years). Spectra Precision LLC or its authorized service center will repair or replace, at its option, any defective part, or the entire product, for which notice has been given during the warranty period. If required, travel and per diem expenses to and from the place where repairs are made will be charged to the customer at the prevailing rates. Customers should send the product to Spectra Precision LLC or the nearest authorized service center for warranty repairs or exchange, freight prepaid. Any evidence of negligent, abnormal use, accident, or any attempt to repair the product by other than factory-authorized personnel using Spectra Precision LLC certified or recommended parts, automatically voids the warranty. Special precautions have been taken to ensure the calibration of the laser; however, calibration is not covered by this warranty. Maintenance of the calibration is the responsibility of the user.

The foregoing states the entire liability of Spectra Precision LLC regarding the purchase and use of its equipment. Spectra Precision LLC will not be held responsible for any consequential loss or damage of any kind. This warranty is in lieu of all other warranties, except as set forth above, including any implied warranty merchantability of fitness for a particular purpose, are hereby disclaimed. This warranty is in lieu of all other warranties, expressed or implied.

TECHNICAL DATA

Laser

Leveling accuracy ^{1,3} :	± 1.5 mm/30 m, 1/16" @ 100 ft, 10 arc seconds
Rotation speed:	0, 10, 80, 200, 600 rpm
Operational area ^{1,2} :	appr. 400 m (1300 feet) radius with detector
Laser type:	HV302: 600-680 nm/HV302G: 520 nm
Laser class:	Class 3A/3R, max. 5 mW
Self-leveling range:	appr. ± 5° (± 9%)
Leveling indicators:	LED flashes
Radio range (HL760/HL760U):	up to 100 m (330 ft)
Power source:	10000mAh NiMH battery pack
Battery life ¹ HV302/HV302G:	45/30 hours NiMH; 60/25 hours alkaline
Operating temp.:	-20°C to 50°C (-4°F to 122°F)
Storage temp.:	-20°C to 70°C (-4°F to 158°F)
Tripod attachments:	5/8 x 11 horizontally and vertically
Dust and Water proof:	IP66
Weight:	3.1 kg (6.8 lbs)
Low voltage indication:	LED battery indicator
Low voltage disconnection:	unit shuts off

1) at 21° Celsius

2) under optimal atmospheric circumstances

3) along the axis

TECHNICAL DATA

Remote Control RC402N

Radio operating range ¹ :	up to 100 m (330 ft)
Power source:	2 x 1.5V AA alkaline batteries
Battery life ¹ :	130 hours
Dust and Water proof:	IP66
Weight (incl. Batteries):	0.26 kg (0.57 lbs)

DECLARATION OF CONFORMITY

Please disregard the declaration of conformity within the manual.

Following is the valid declaration:

We

Spectra Precision (Kaiserslautern) GmbH

Declare under our sole responsibility that the products

HV302/HV302G and RC402N

to which this declaration relates is in conformity with the following standards:

EN300 440-2 V1.1.1:2004, EN301 489-03 V1.4.1:2002, EN301 489-01 V1.4.1:2002, EN50371:2002

following the provisions of directive **R&TTE 1999/5/EC**

The managing director

Electro-Magnetic Compatibility

Compliance statement (part 15.19) This device complies with part 15 of the FCC Rules. Operation is subject to the following two conditions: (1) this device may not cause harmful interference, and (2) this device must accept any interference received, including interference that may cause undesired operation. Warning (part 15.21) Changes or modifications not expressly approved by the party responsible for compliance could void the user's authority to operate the equipment. This in particular is applicable for the antenna which has been delivered with the HV302/HV302G and RC402N Under Industry Canada regulations, this radio transmitter may only operate using an antenna of a type and maximum (or lesser) gain approved for the transmitter by Industry Canada. To reduce potential radio interference to other users, the antenna type and its gain should be so chosen that the equivalent isotropically radiated power (e.i.r.p.) is not more than that necessary for successful communication.

Spectra Precision HV302/HV302G

User Guide

Contact Information:

AMERICAS

Spectra Precision (USA) LLC
3265 Logistics Lane, Suite 200
Dayton, OH 45377 USA
888-527-3771 (Toll Free)

www.spectraprecision.com

EUROPE, MIDDLE EAST, AFRICA

Spectra Precision (Kaiserslautern) GmbH
Am Sportplatz 5
67661 Kaiserslautern
Germany
+49-6142-2100-0 Phone



© 2023, Spectra Precision LLC. All rights reserved.
Reorder PN 101180-00 Rev E (11/23)